

CLAVIS

New Technology. Upgrade Your Life.

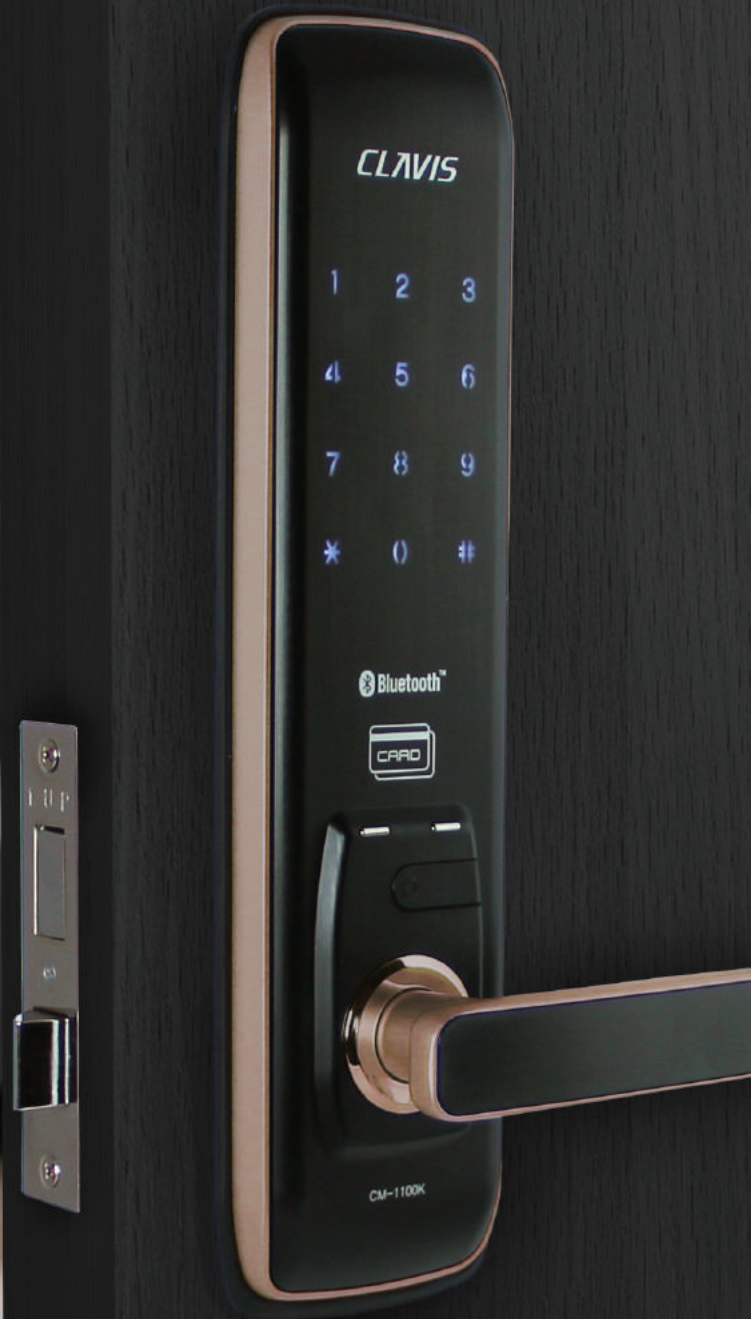

Made in Korea



Door Access Solutions

for Commercial, Institutional and Residential projects in Hong Kong and Macau.

We carry a wide portfolio of Products & Solutions including Automatic Doors, Large-Surface Sliding Windows, Architectural Ironmongery, Security Gates, Access Control and Industrial Doors.

Service is our Value - we offer Technical Advice & Customized Drawings, Ironmongery Schedules, Master Key Plans, Project Management, Supply & Installation, Training and Maintenance programs.

Key partners and suppliers include GILGEN Door Systems, DormaKaba Security Solutions, EFAFLEX High-Speed Doors, HART Security Shutters, ABUS Security Tech Germany, TBS Biometric Solutions and AIR-LUX Window Systems.

Our experienced team with its in-depth market knowledge, product know-how and business experience is driving AUB Ltd to become a leading brand in the Industry.



Biometric Fingerprint Smart Lock



**NEW
PRODUCT**

CLAVIS

Outstanding experience in Digital
Door Lock Technology
Manufactured in Korea

CMF-1000K

Functions Description

Convenience



One Touch to Open

The door can be opened without any password and key as long as you have the Smart Phone on you (in your pocket/handbag). The lock automatically recognizes the Smart Phone over a distance of up to (around) 1m.



Automatic Locking

The door is automatically locked after closing.



Compatible with Smart Phone

Compatible with Smart Phone to open the lock remotely and checking access history and etc.



Capacitive Fingerprint Sensor

8K algorithm enables quick authentication even when only part of the fingerprint is scanned.

Safety



External Forced Locking

When leaving, the user can set up the External the Locking mode by simply pressing PIN code, preventing burglar by creating alarm.



Internal Forced Lock

Inside locking button engaged doubles security and improves safety.



Wrong-Try Lock-Out

All the functions are stopped for duration of 1~2 minutes if an unregistered P/W is entered 3 times or more.



Fake PIN Code

Press any password before you input the correct password. This function prevents password exposure.



Burglar (Break-in / Damage) Alarm

Built-in sensors will detect any case of attempted forcible entry and trigger a loud alarm sound.



High Temperature Alarm

In case of fire, a heat detecting sensor will automatically unlock the door and sound an alarm in case detected temperatures reach 60 (±10).

Function



Volume Control

The user can control the volume.



Silent Mode

The door lock offers a silent mode if the user does not want key pad volume.



Low Battery Warning Sound

A sound will ring when the door is open/closed indicating the need to replace batteries.



Emergency Power Supply

This product is designed to use an emergency external power source (9V) in case of dead batteries.



Master Function

Passwords / Card sets are available for master key for overall management (e.g. one card for access to multiple door locks)



Advance Mode

Advance mode optional for professional and high secure management system.

Biometric Fingerprint Smart Lock

CMF-1000K
CMF-1100K



EN1634-1



ACCESS



Capacitive
Fingerprint

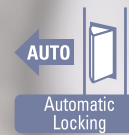

Automatic
Locking



Fingerprint



Internal Forced
Lock



Fake PIN Code



High Temperature
Alarm



Burglar (Break-in/
Damage) Alarm



Wrong-Try
Lock-Out



Emergency Power
Supply



Low Battery
Warning signal



Silent Mode



Advance Mode



Volume Control

CLAVIS

New Technology. Upgrade Your Life.



Slim is fashionable!!

Capacitive Fingerprint Sensor

With a thickness of only 16mm, our lock is among the thinnest on the market.



State-of-the art capacitive fingerprint sensor with LED backlight for visual feedback. 8K algorithm enables quick authentication even when only part of the fingerprint is scanned. Automatic machine learning function improves recognition speed over time.

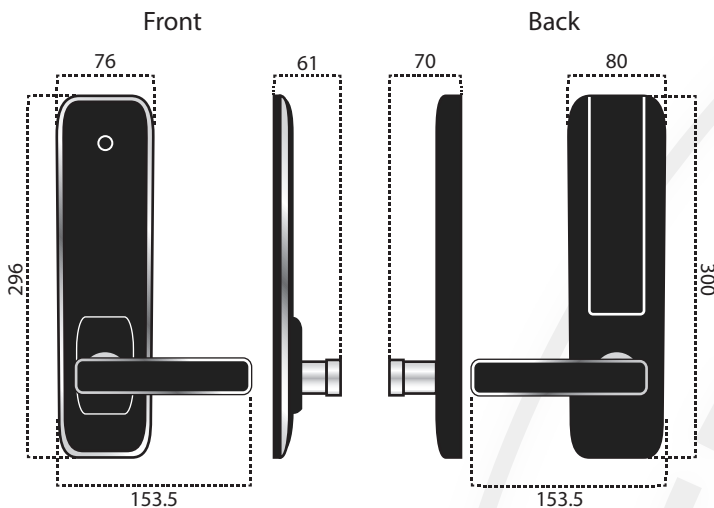

- Automatic Locking
- Internal Force Lock (Privacy Mode)
- Fake PIN Code (PIN Scramble)
- High Temperature Alert
- Burglar (Break-in/Damage) Alarm
- Wrong-Try Lock-Out
- Emergency Power Supply (9V)
- Residential / Commercial Mode
- Low Battery Notification
- One Time Manner Mode
- Volume Control
- Home Automation Interface (optional)
- Mechanical Key Override
- Up to 100 Fingerprints
- Up to 30 RFID Cards
- Up to 38 PIN Codes

Standard Finishes:



CM-1000K

ACCESS



Parts	Specification
Front (Front Body)	296(H) × 76(W) × 20(D)
Back (Back Body)	300(H) × 80(W) × 30(D)
Door Thickness	50-60mm
Battery	DC 6V(AA alkaline batteries × 4)
Battery Life	Up to 10months (10times a day)
Capacity	Password: 1
	RFID Card: 20



Finishes:



CM-1100K

ACCESS

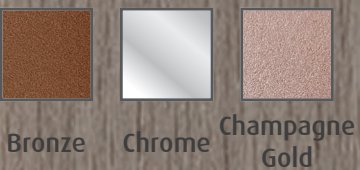

Parts	Specification
Front (Front Body)	296(H) × 76(W) × 20(D)
Back (Back Body)	300(H) × 80(W) × 30(D)
Door Thickness	50-60mm
Battery	DC 6V(AA alkaline batteries × 4)
Battery Life	Up to 10months (10times a day)
Capacity	Password: 1 RFID Card: 20 Mobile Phone: 8

CM-1100K can control by smartphone application quick and simple .

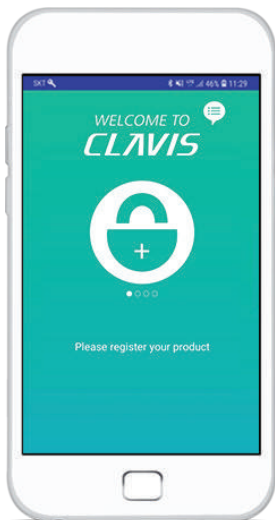

CLAVIS smartphone App Function One Touch to Open

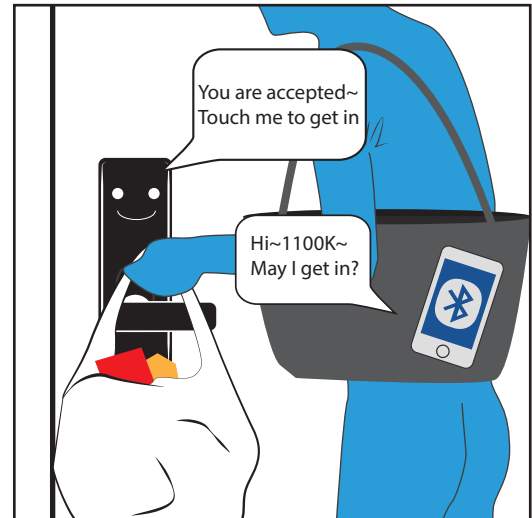
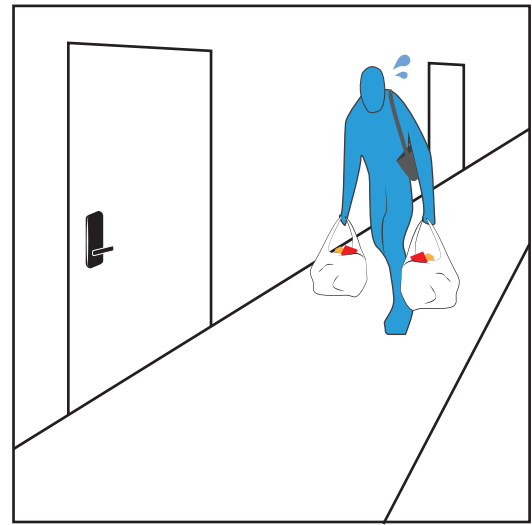

One touch keypad, the lock automatically recognizes the Smart Phone

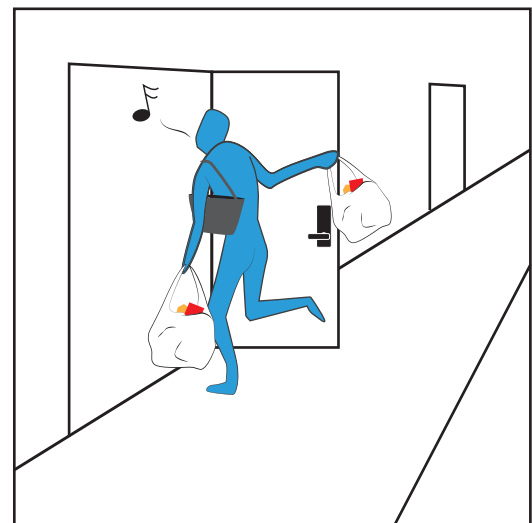

The door can be opened without any password and key

CLAVIS smartphone App Function Cloud Key - Remote Opening

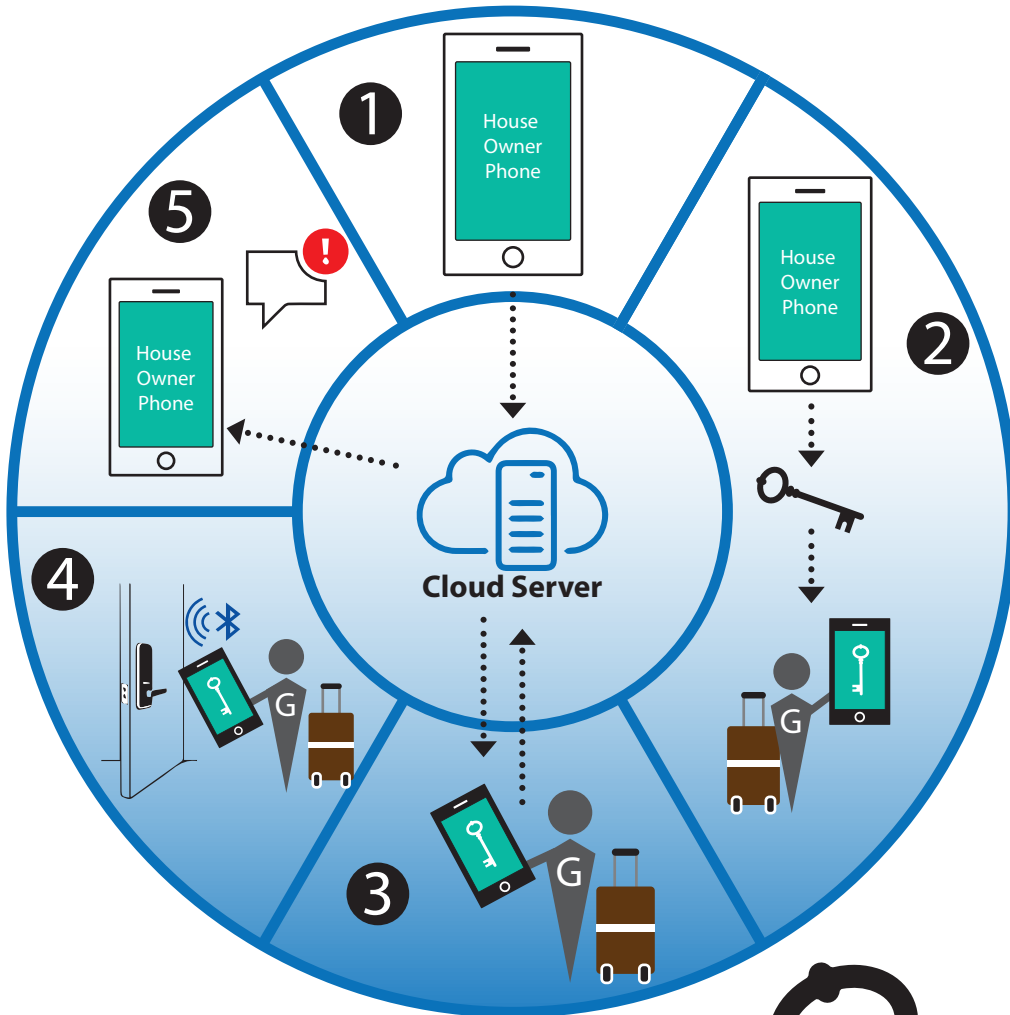

- 1 House Owner Register Guest Valid Access period
- 2 Send Cloud Key to the Guest
- 3 Connect to Cloud Server
- 4 Using Clavis app to unlock by Bluetooth
- 5 Real Time Notification From Cloud Server





AUB Limited
Unit A, 12/F, Hung Mou Industrial Building,
62 Hung To Road, Kwun Tong,
Kowloon, Hong Kong

Tel : +852 2375 6110
Fax : +852 2406 2602

Email : enquiry@aub.com.hk
www.aub.com.hk