

ALB

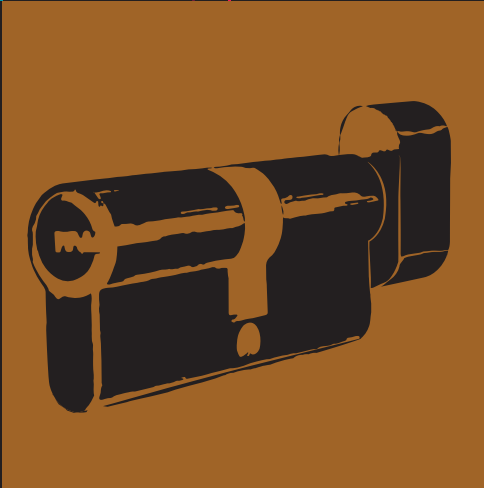

**Control
The
Door**

**Door
Hardware**

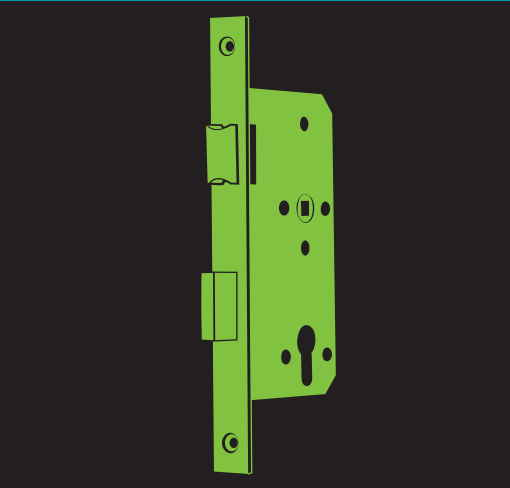
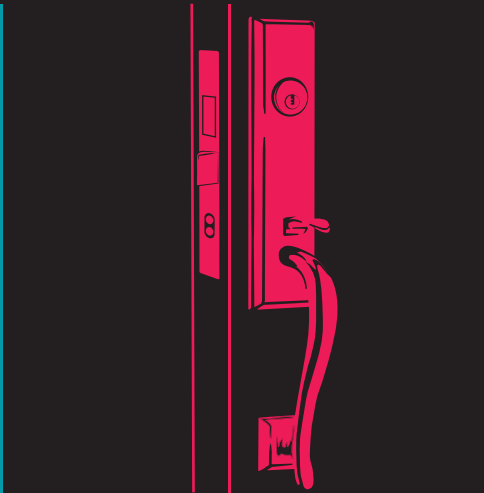
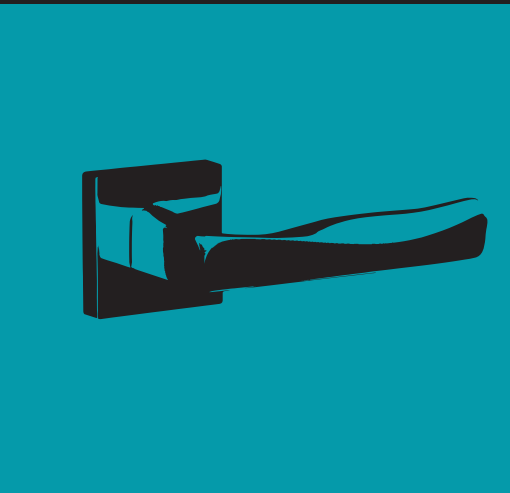

About Us



Door Access Solutions for Commercial, Institutional and Residential projects in Hong Kong and Macau.

We are offering a wide portfolio of Products & Solutions including Automatic Doors, Windows & Entrance, Hardware & Interior Doors, Security Gates, Access Control and Industrial Doors.

Service is our Value - we provide Technical Advice & Customized Drawings, Ironmongery Schedules, Master Key Plans, Supply & Installation, Contracting, Training and Service & Maintenance programs and Sourcing.

We exclusively represent GILGEN Door Systems, a leading supplier of Automatic Door solutions from Switzerland.

Key partners include AIR-LUX Window Systems, the DOR-MAKABA Group, EFAFLEX High-Speed Doors, ABUS Security Tech Germany and TBS Biometric Solutions.

Our experienced team with its in-depth market knowledge, product know-how and business experience is driving AUB Ltd to become a leading brand in the Industry.

Content



Page 3 - 13

Lever Handle



Page 14 - 18

Min Entrance Lockset



Page 19 - 23

Lock Case



Page 24 - 28

Master Key Systems

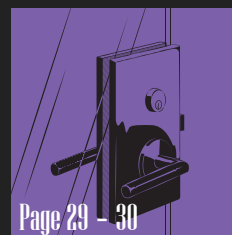

Page 29 - 30

Glass Lock



Page 31 - 32

Industrial Lock

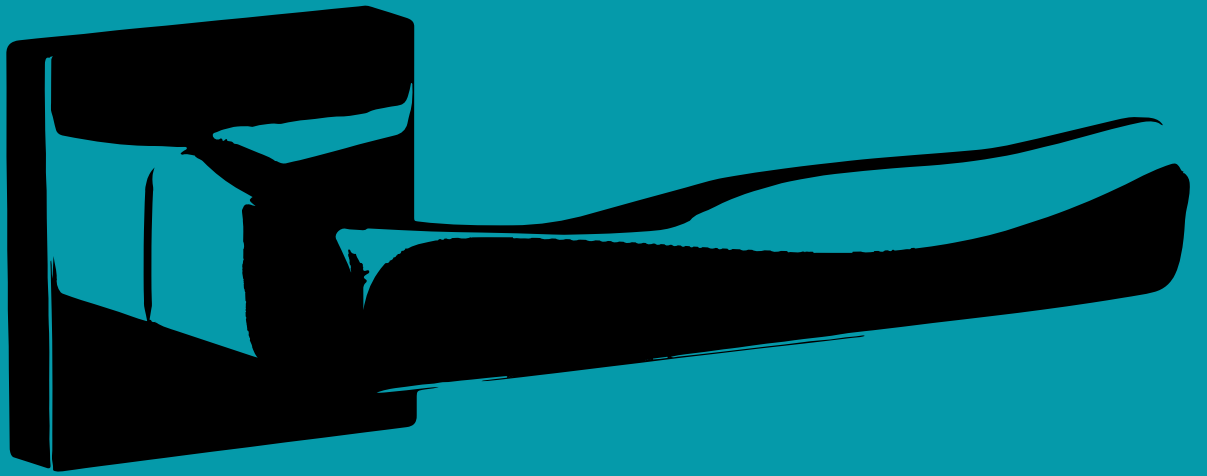

Lever Handle

ALB Allegra

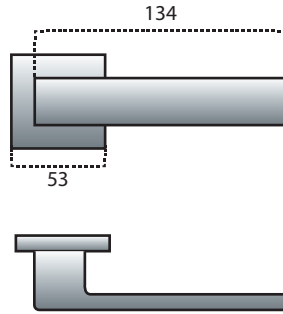
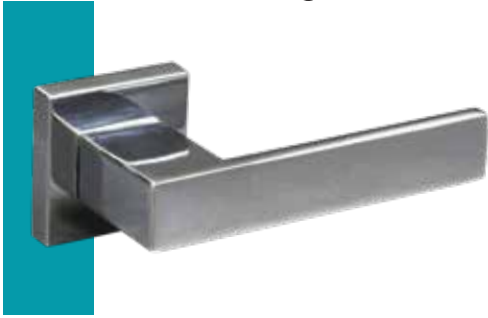

Standard Finishes:

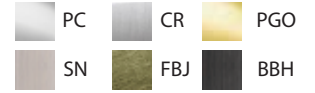

ALB Angioletta

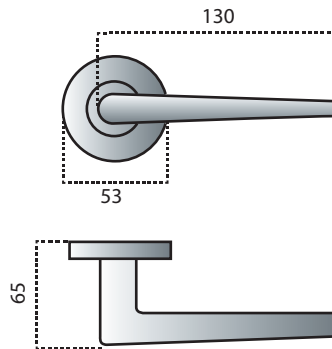

Standard Finishes:

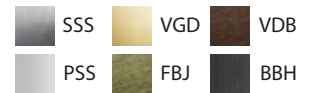

ALB Anna

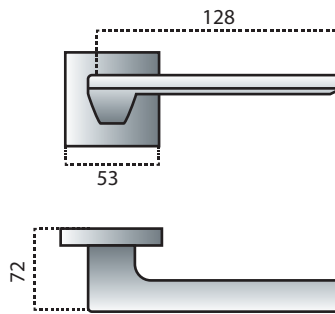

Standard Finishes:

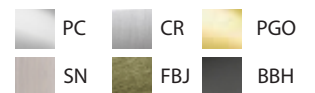

ALB Aria

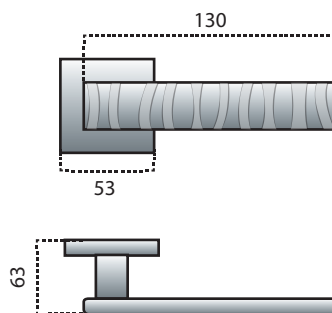
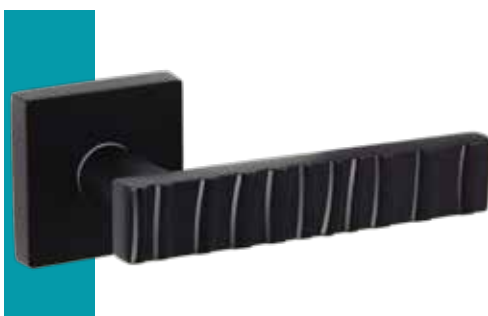

Standard Finishes:

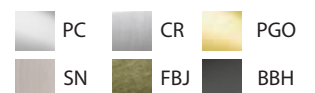

AUR Beatrice

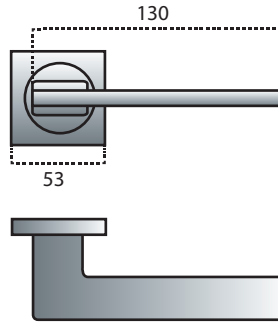

Standard Finishes:



AUR Beds

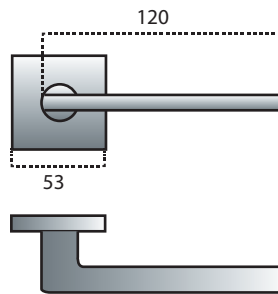

Standard Finishes:

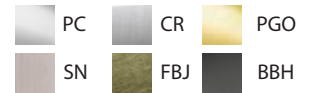

AUR Bershire

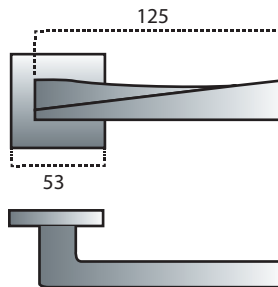

Standard Finishes:

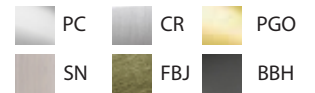

AUR Bute

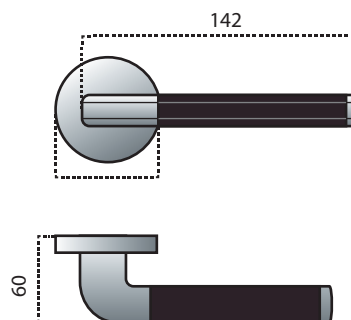

Standard Finishes:

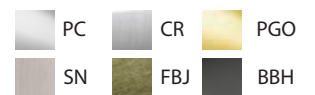

ALB Cheshire

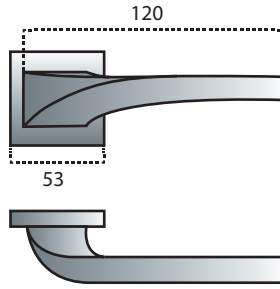

Standard Finishes:



ALB Chole

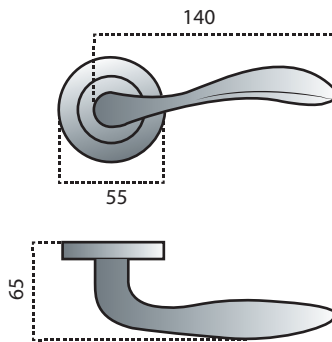

Standard Finishes:

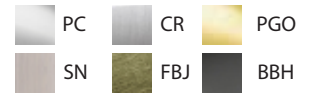

ALB Claire

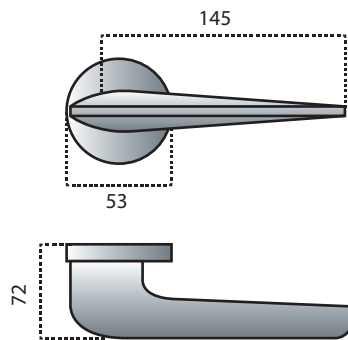

Standard Finishes:

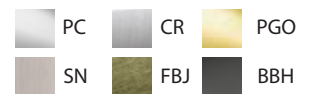

ALB Durham

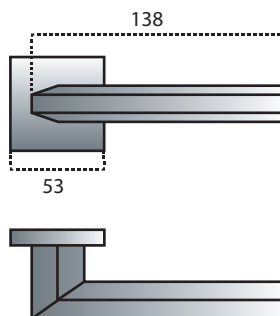
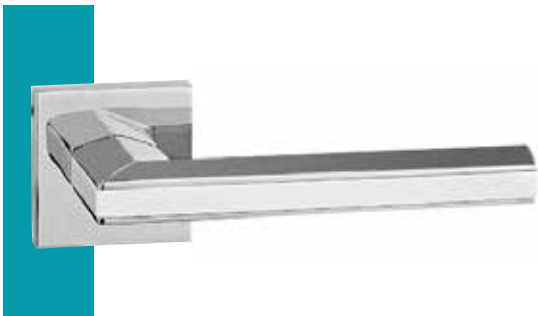

Standard Finishes:

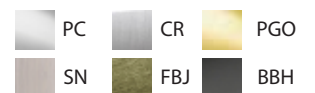

AUB Edinburgh

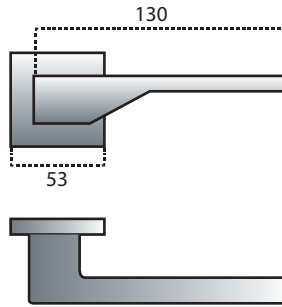

Standard Finishes:



AUB Fife

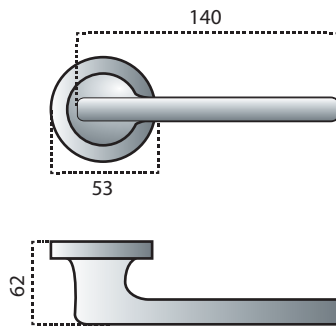

Standard Finishes:

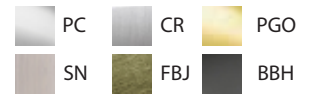

AUB Glam

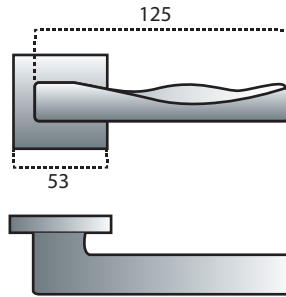

Standard Finishes:

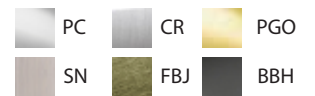

AUB Grampian

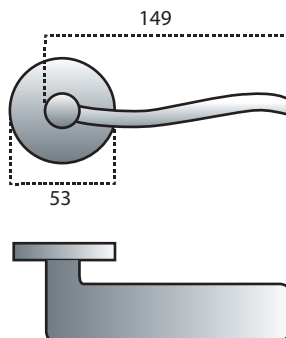



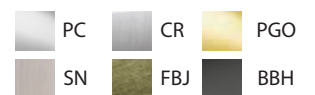

Standard Finishes:

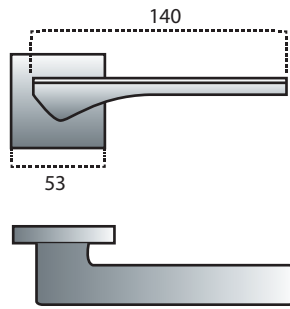
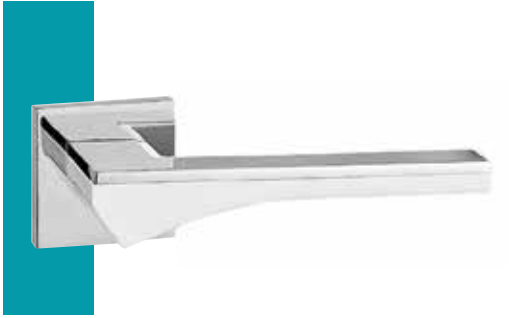

ALB Humber





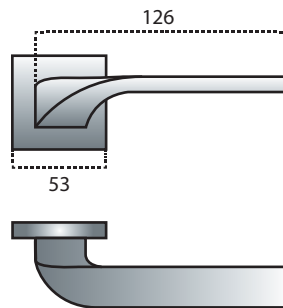

Standard Finishes:

-  PC
-  CR
-  PGO
-  SN
-  FBJ
-  BBH

ALB Koni







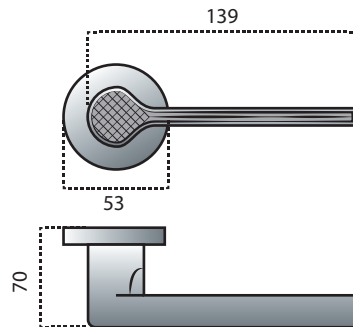

Standard Finishes:

-  PC
-  CR
-  PGO
-  SN
-  FBJ
-  BBH

ALB Kay







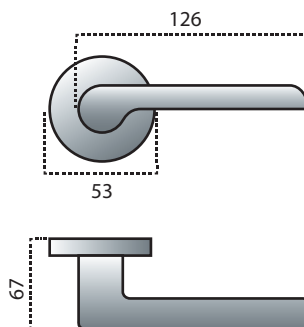

Standard Finishes:

-  PC
-  CR
-  PGO
-  SN
-  FBJ
-  BBH

ALB Kylie



Standard Finishes:

-  PC
-  CR
-  PGO
-  SN
-  FBJ
-  BBH

AUB Layla

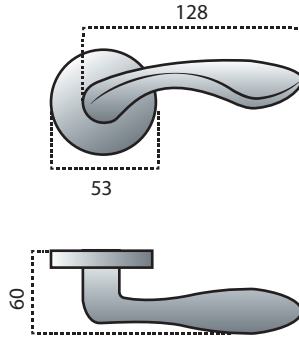

Standard Finishes:



AUB Lincoln

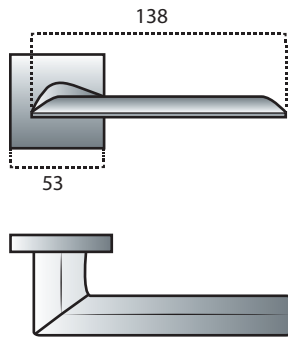

Standard Finishes:

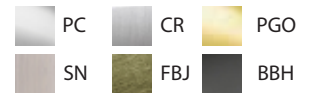

AUB Luca

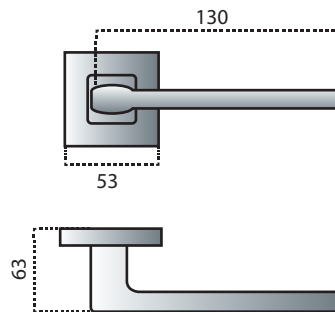

Standard Finishes:

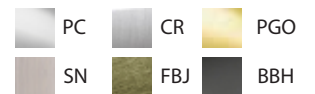

AUB Naples

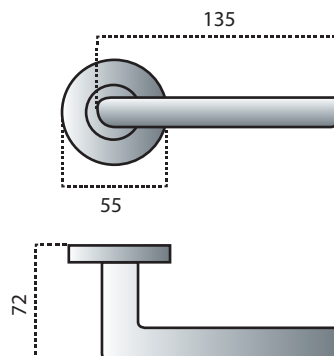
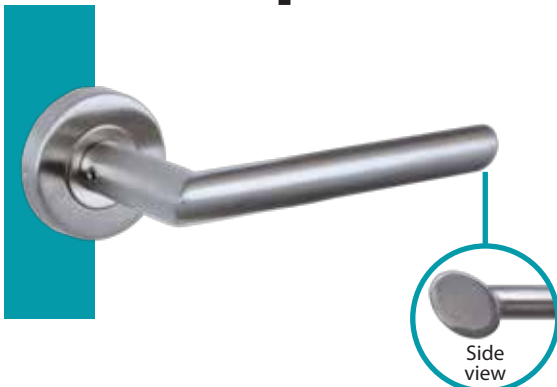

Standard Finishes:

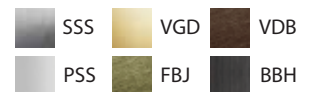

AUR Notts

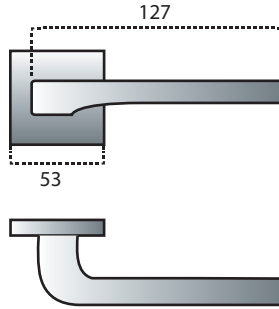

Standard Finishes:



AUR Oxford

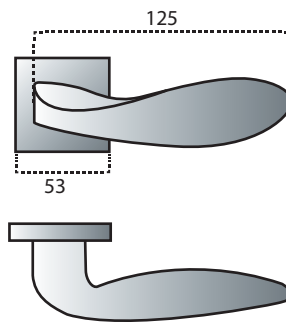

Standard Finishes:

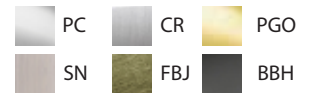

AUR Piper

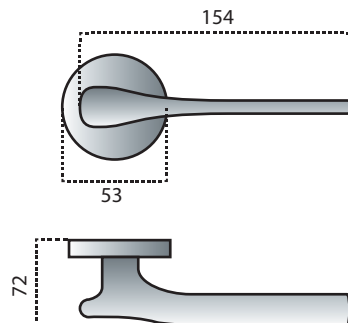

Standard Finishes:

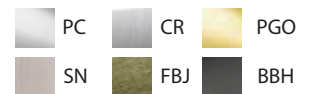

AUR Riley

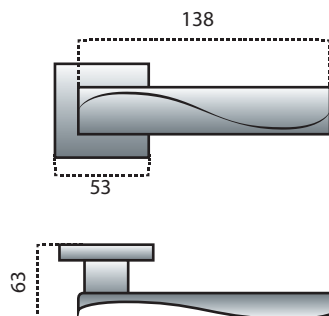

Standard Finishes:

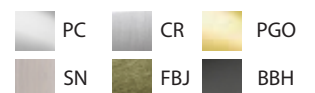

AUB Sarah

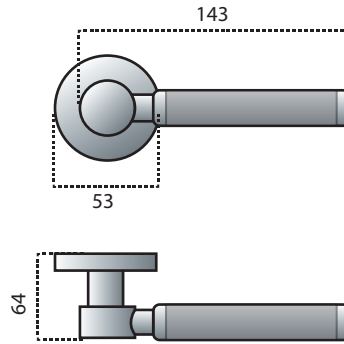

Standard Finishes:



AUB Serena

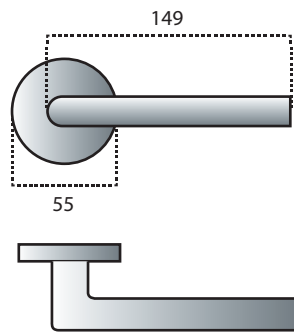
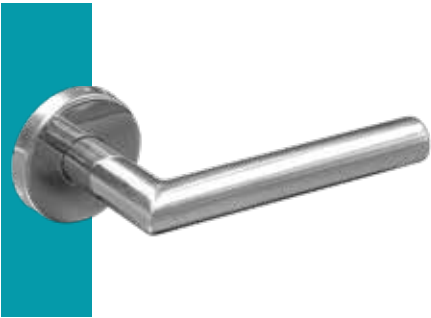

Standard Finishes:

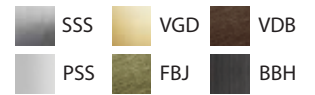

AUB Shetland

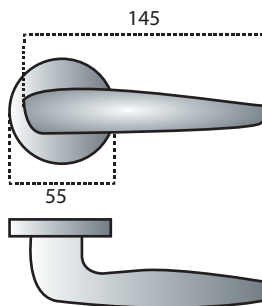

Standard Finishes:

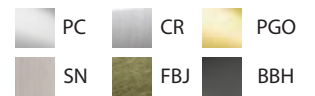

AUB Tecla

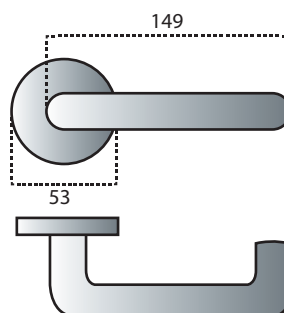

Standard Finishes:

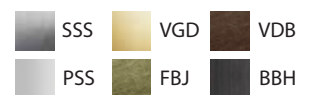

ALB Vivi

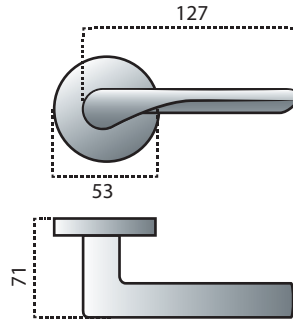





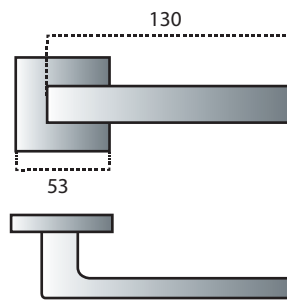

Standard Finishes:

-  PC
-  CR
-  PGO
-  SN
-  FBJ
-  BBH

ALB York







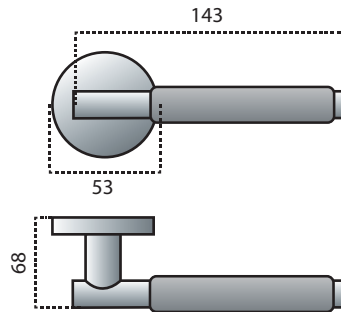

Standard Finishes:

-  PC
-  CR
-  PGO
-  SN
-  FBJ
-  BBH

ALB Zoey



Standard Finishes:

-  PC
-  CR
-  PGO
-  SN
-  FBJ
-  BBH



Frascio®



KAWAJUN



 **Randi**



halcö
Tradition + High-Tech



REGUCCI®
Handles & Accessories



HEWI

Main Entrance Lockset



AUB Residential Lock

Evelyn

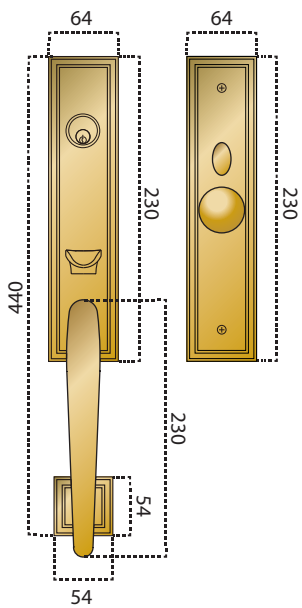

Levi

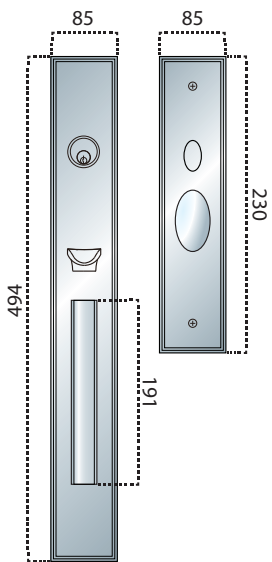

Aurora

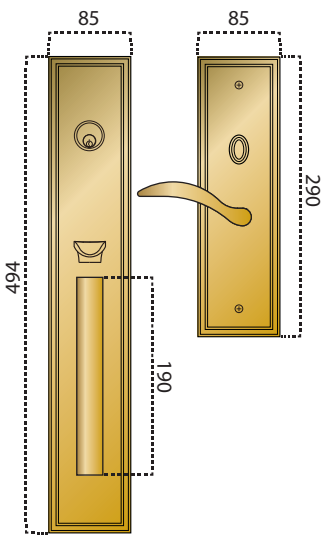

Ethan

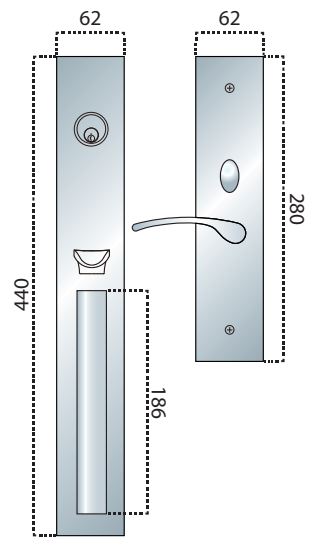

Molly



Landen

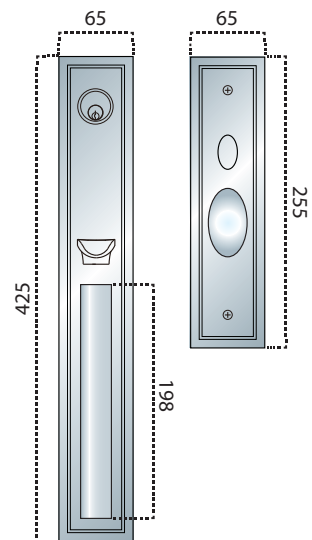
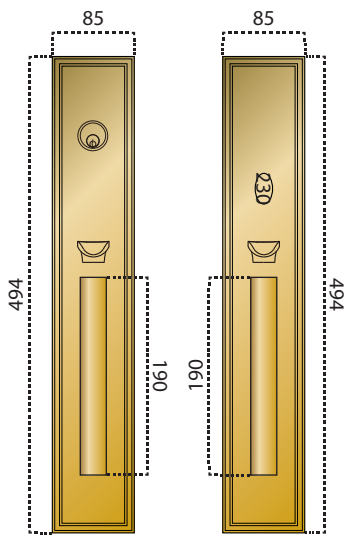

Assemble your own lock

Press



Pull Handle



Turn Piece



Knob



Lever Handle



Standard Finishes:

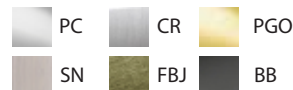

CLAVIS



Made in Korea

Residential Digital Lock Fingerprint

CMF-1000K

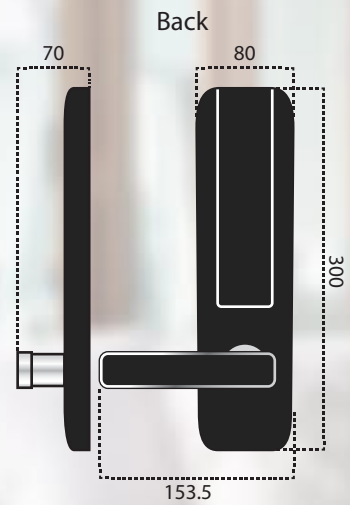
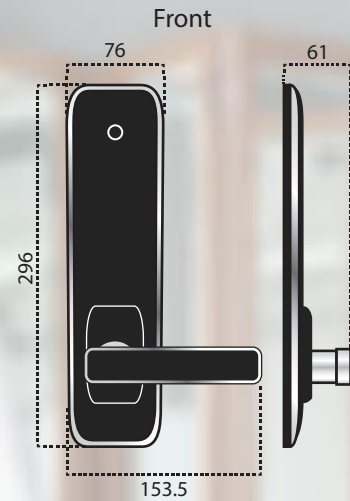

ACCESS



Capacitive Fingerprint



* for CMF-1100K only

- Automatic Locking
- Internal Force Lock (Privacy Mode)
- Fake PIN Code (PIN Scramble)
- High Temperature Alert
- Burglar (Break-in/Damage) Alarm
- Wrong-Try Lock-Out
- Emergency Power Supply (9V)
- Residential / Commercial Mode
- Low Battery Notification
- One Time Manner Mode
- Volume Control
- Home Automation Interface (optional)
- Mechanical Key Override
- Up to 100 Fingerprints
- Up to 30 RFID Cards
- Up to 38 PIN Codes



EN1634-1

CLAVIS Residential Digital Lock

CM-1000K

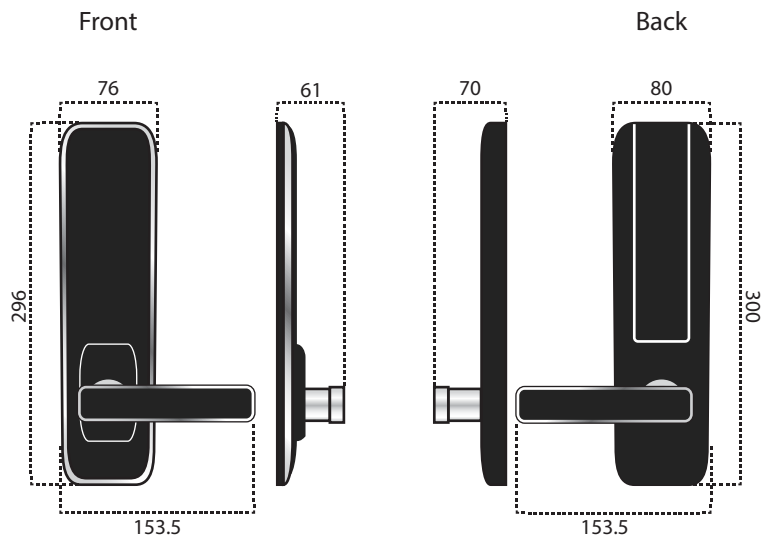

- Automatic Locking
- High Temperature Alarm
- Burglar (Break-in/Damage) Alarm
- Wrong - Try Lock - Out
- Internal Forced Lock
- Fake PIN Code

- Silent Mode
- Advance Mode
- Volume Control
- Emergency Power Supply
- Low Battery Warning Signal

CM-1100K

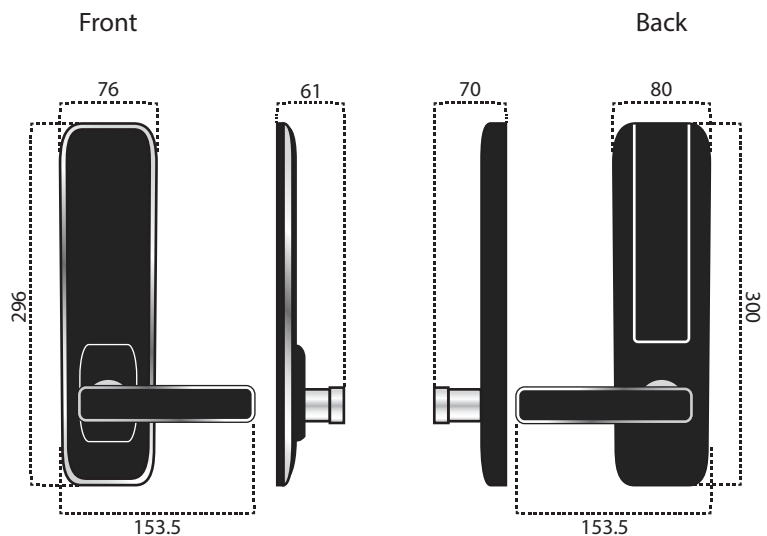

- Automatic Locking
- One Touch To Open
- Compatible With Smart Phone
- High Temperature Alarm
- Burglar (Break-in/Damage) Alarm
- Wrong - Try Lock - Out
- Internal Forced Lock

- Fake PIN Code
- Silent Mode
- Advance Mode
- Volume Control
- Emergency Power Supply
- Low Battery Warning Signal

Standard Finishes:

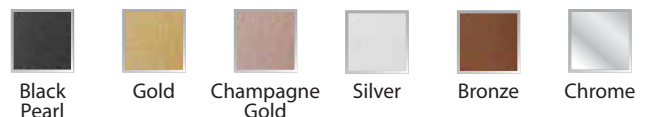

Lock Case

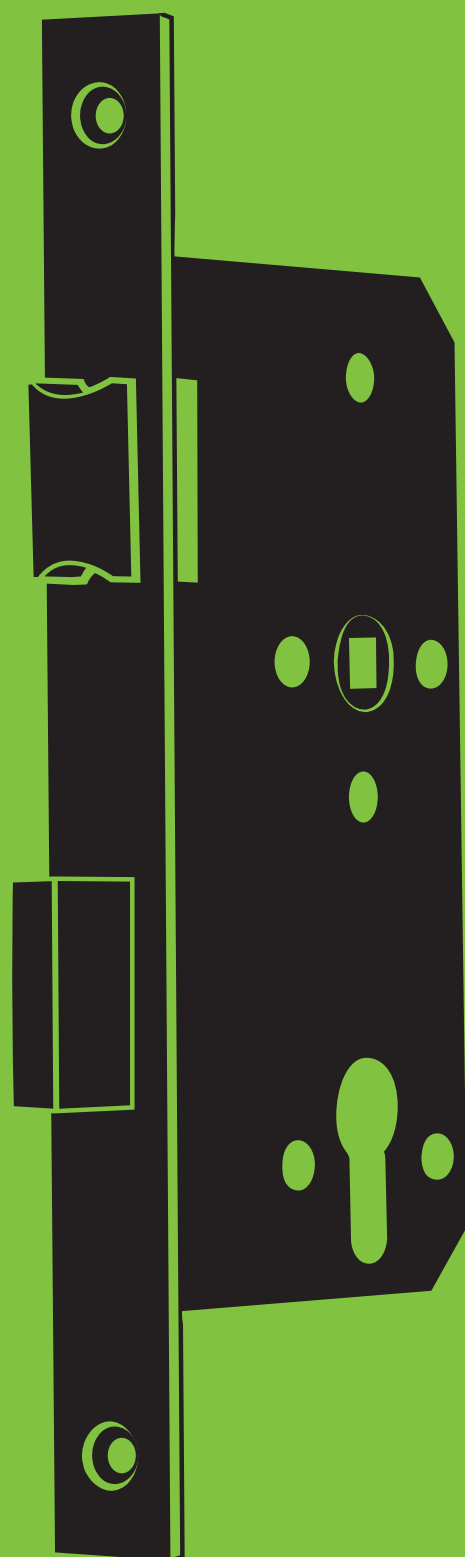



Euro Lockcase Tech uC Sash Lock

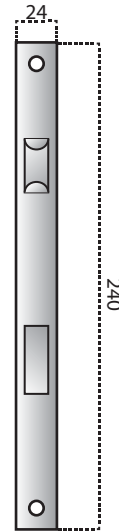
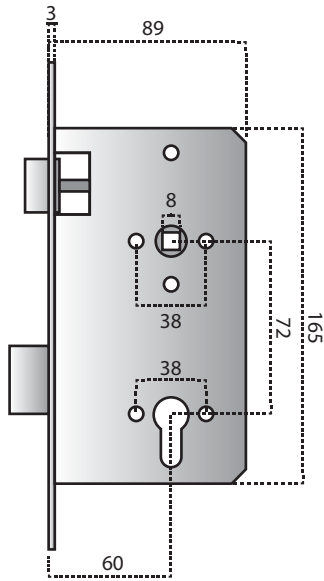

Product Description

- Heavy Quality Europe Profile Mortise Lock

Function

- Entrance

Standard Finishes:



Euro Lockcase Tech uC Latch

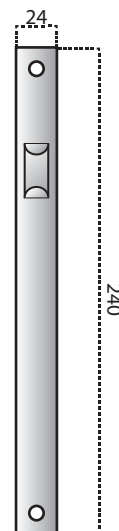
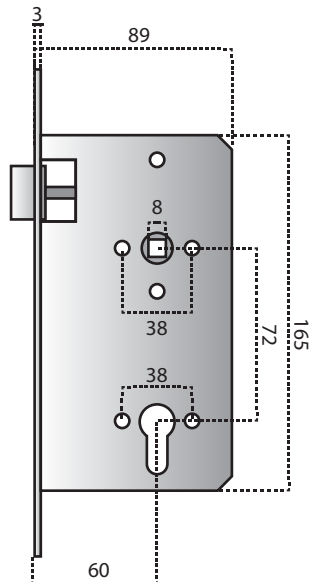

Product Description

- Heavy Quality Europe Profile Mortise Lock

Function

- Passage

Standard Finishes:





Euro Lockcase Tech uC Dead Lock

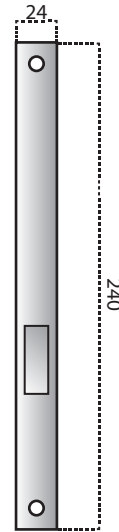
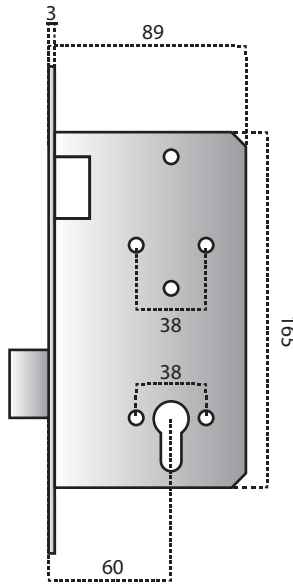

Product Description

- Heavy Quality Europe Profile Mortise Lock

Function

- Dead Lock for Cylinder

Standard Finishes:



Euro Lockcase Tech uC Night Latch

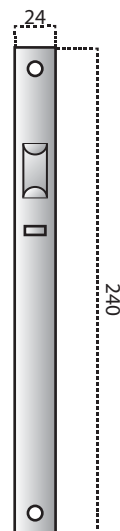
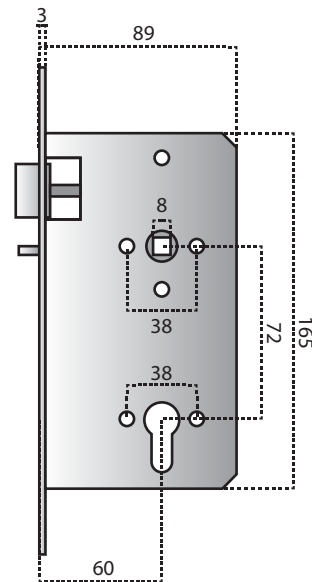

Product Description

- Heavy Quality Europe Profile Mortise Lock

Function

- Night-latch

Standard Finishes:





Euro Lockcase Tech uC Bathroom



EN12209
EN1634-1

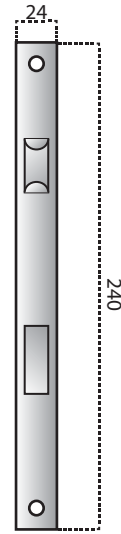
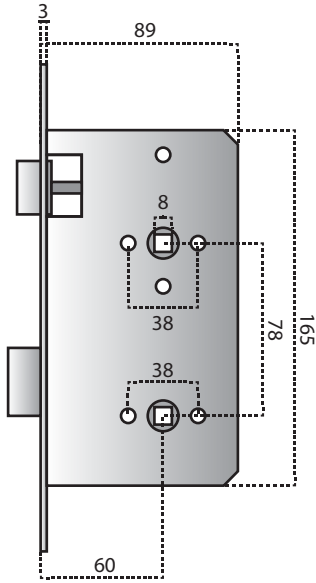

Product Description

- Heavy Quality Europe Profile Mortise Lock

Function

- Privacy

Standard Finishes:



Ansi Lockcase Tech B Entrance Function

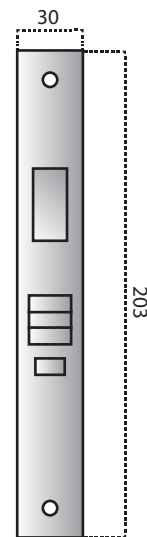
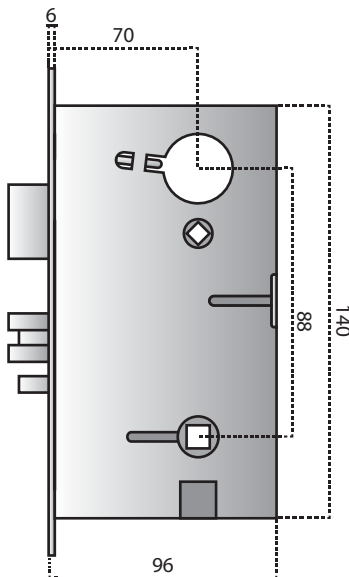

Product Description

- Heavy Duty Mortise Lock With
Non-headed Design for Residential Use

Function

- Main Entrance
- Automatic Lock
- Emergency Egress

Standard Finishes:



Glutz

Security Mortice Lock



Standards

- Firetested by BRE up to 4 hours
- Certified ANSI/BHMA 156.13, grade 1, at ITS in USA
- EN 1634-1: EI 90
- EN 12209: 3X510F7HA30

Standard version

- With latch withdrawal
- Backset 60 mm
- Centres 72 mm for 4829 profile cylinder
- Centres 74 mm for 4839 round cylinder
- Forend 235x25 mm, radiused or rectangular
- Forend satin stainless steel
- Clamp follower 8 mm
- Antifriction lever latch
- Single throw deadbolt, 24 mm
- With anti-thrust latch

Glutz

High Security Multipoint Lock



Standards

- EN1634-1
- DIN18251-3
- EN1627-1630 RC4

Standard version

- PZ/RZ 78 mm: DM 60, 70, 80 mm
- PZ 72 / 92 mm: DM 65, 70, 80 mm
- PZ 88 mm: DM 65, 80 mm
- Matt stainless steel radiussed forend 20 x 3 mm
- 4-part clamp follower; square 8 / 8,5 / 9 / 10 mm
- Lock case compatible with Glutz protection fittings
- Smooth-running latch withdrawal for drawing back the latch
- Hardened main bolt; Shot out 20 mm
- Four additional hardened bolts; Shot out 20 mm
- Dampened, reversible DIN L + R comfort latch with latch blocking
- Simultaneous latch locking and lever handle disconnection, when locked

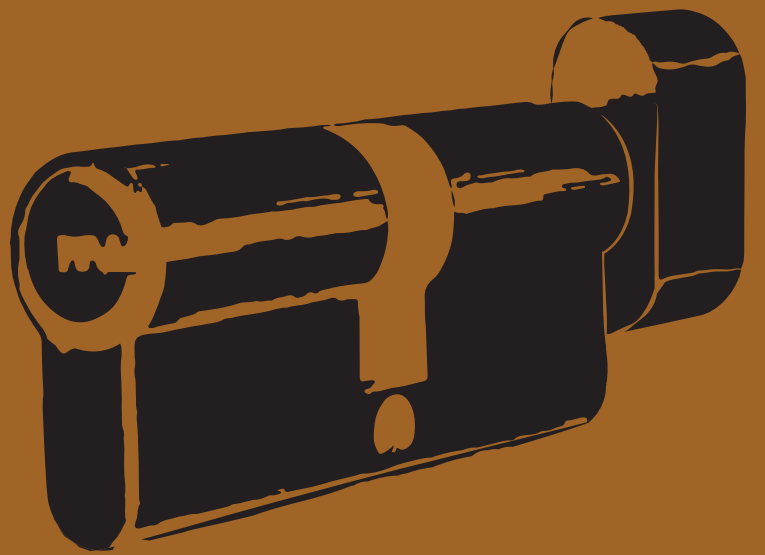

Master Key Systems

AUE Keying Combinations

Types of combinations

Keyed to Differ

Each can only be opened by its own individual key.



Keyed Alike

Allows for a number of locks to be opened by the same key. There is no limit to the number of locks that can be keyed alike.

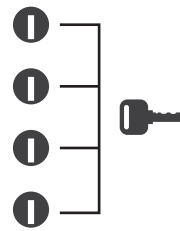

Keyway

Schlage
Yale
Dimple

Keyway

Schlage
Yale
Dimple

Master Key Systems (MKS)

Each lock has its own individual key which will operate no other lock in the system. There is a master key which will operate all locks in the system.

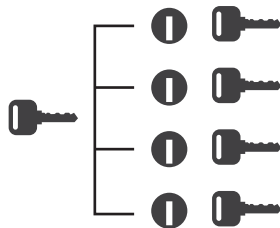

Grand Master Key Systems (MKS)

Each lock has an individual key and the locks are divided into two or more groups. Each group of locks is operated by one Master Key with an overall Grand Master Key.

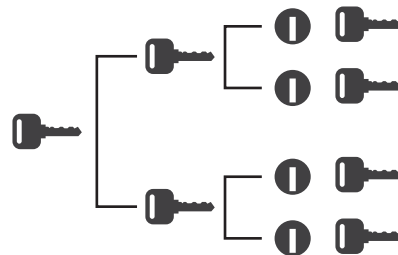

Keyway

Schlage
Yale

Keyway

Schlage
Yale

Master keying System can be applied across different cylinder types to enhance more design needs and security flexibility.

Definition of keys in Master Key Systems

Grand Master Key (GMK)

Such a key usually fits all cylinders with a master key system, excluding lockers for personal use

Master Key (MK)

This type of key is primarily used in systems with many individual keys and superimposed main group keys

Individual key (IK)

The individual key is at the bottom of the hierarchy. It is only possible to lock individual cylinders (perhaps a central cylinder as well)

Available cylinder type

Euro-profile Cylinder

Single Cylinder



Double Cylinder



Cylinder & Turn



Screw-in Cylinder



Rim Cylinder



dormakaba expert^T Euro-profile Cylinder

Single Cylinder

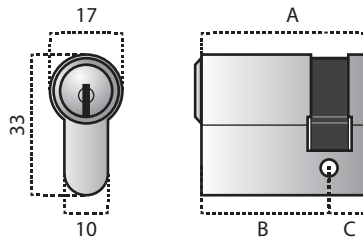

Double Cylinder

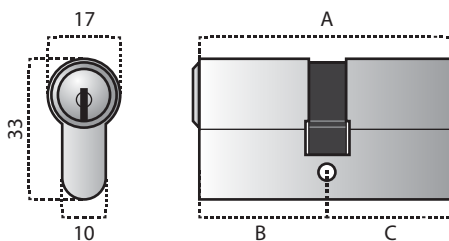

Cylinder & Turn

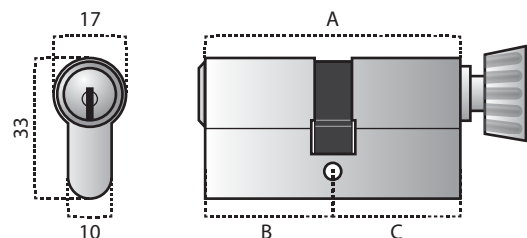

dormakaba ESZ 508-100-718 Screw-in Cylinder

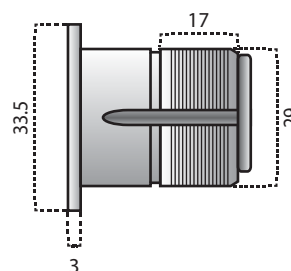

dormakaba **experT** Screw-on Dead Lock MAS1012

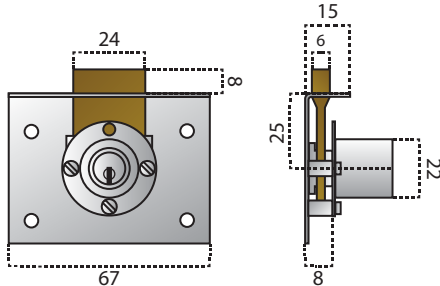

dormakaba **experT** Screw-on Dead Lock MAS1074

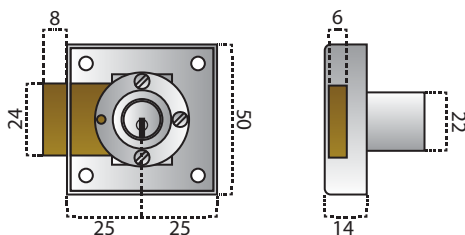

dormakaba **experT** Screw-on Latch Lock MAS1075

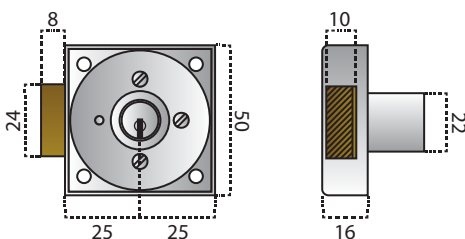

dormakaba **experT** Flush Dead Lock MAS2006

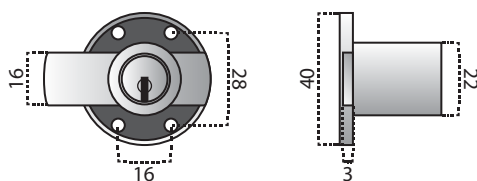

dormakaba **experT** Flush Dead Lock MAS2006A

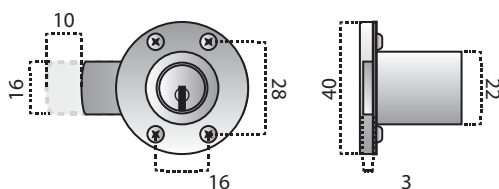

Glass Lock



ASSA ABLOY Vertis Lock for Euro profile cylinder

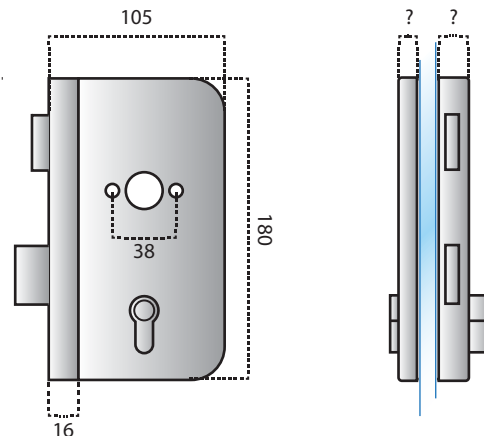

- For 8- 10 and 12 mm thick toughened glass
- Reversible
- Locked by key with forward motion of latch bolt
- Retractable latch bolt by key
- Supplied with flat keep

Fits 8-10 and 12mm Glass

Standard Finishes:

- Brushed anodised alu silver
- Brushed stainless steel

ASSA ABLOY Lumira Latch set with Handles

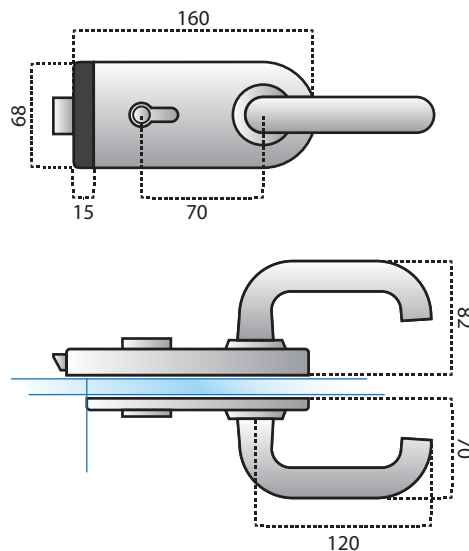

- For 8-10 and 12 mm thick toughened glass
- With spring and dead bolt

Fits 8-10 and 12mm Glass

Standard Finishes:

- Brushed anodised alu silver
- Brushed stainless steel

Outdoor Lock



LOCINOX

LAKQ U2 Outdoor Lock

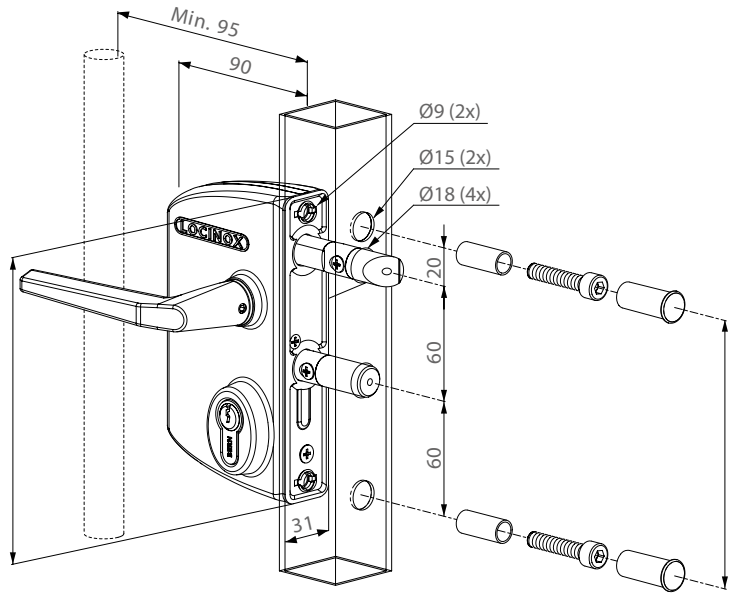

- ISO 9227 KTL / E-coated lock box withstands 1000 hours of salt spray test
- Easy left or right changing of the self-latching daybolt
- 23 mm throw of the dead bolt, in 1 turn of the key
- Key-operated self-latching bolt
- 4-hole fixing with two hexagon socket head screws
- 60 mm center distance of the bolts
- Continuous adjustment of the daybolt up to 20 mm without dismounting the lock box
- Stainless steel mechanism

Standard Finishes:

ZILV 6005 6009 7016 9005 9010

Component



SAKL QF



SHKL QF



MODULEC-SA



3006M



3006I



3006D



KIDLOC



PUSHBAR-L-





Door Hardware Finish

Stainless Steel



PSS - Polished Stainless Steel Finish
(Full polish made on material surface)



SSS - Satin Stainless Steel Finish
(Highlined patten apply on material surface)



SSP- Satin Stainless Steel Finish with coating
(Highlined patten apply on material surface with anti fingerprint coating)

Brass



MP - Polished Brass Finish
(Full polish made on material surface)



SB - Satin Brass Finish
(Highlined patten apply on material surface)

Gold Finish



VXG - PVD Gold [X01]
(Champagne like PVD gold on polished surface)



VRG - PVD Rose Gold Finish
(PVD rose gold on polished surface)



VGD - Standard PVD Gold
(PVD gold on polished surface)



PGO - Polished Gold Finish
(Standard PVD gold on polished surface)



PGH - Hairlined Gold Finish
(Standard PVD gold on hairlined surface)

Nickel Finish



PN - Polish Nickel Finish
(Nickel plating on polished surface with semi-gloss sealing)



SN - Satin Nickel Finish
(Nickel plating on hairlined surface with semi-gloss sealing)



PES - Pearl Nickel Finish
(Peralize nickel plating on polished surface with semi-gloss sealing)

Chrome Finish



PC - Polished Chrome Finish
(Chrome plating on polished surface)



CR - Satin Chrome Finish
(Chrome plating on hairlined surface)



PEC - Pearl Chrome Finish
(Peralize chrome plating on polished surface)

Black Finish



JBP - Black Plating Finish
(Standard black on polished surface with semi gloss-sealing)



JBH - Hairlined Black Plating Finish
(Standard black on hairlined surface with semi gloss-sealing)



JBG - Polished Black Plating Finish
(Standard black on polished surface with gloss-sealing)



BB - Brush Black Finish
(Brush black on polished surface with semi gloss-sealing)



BBH - Hairlined Brush Black Finish
(Brush black on hairlined surface with semi gloss-sealing)



VBK - Polished PVD Black Finish
(PVD black on polished surface with semi gloss-sealing)



VBL - Hairlined PVD Black Finish
(PVD black on hairlined surface with semi gloss-sealing)

Bronze Finish



FBJ - Fresh Bronze [JR]
(Anti-bronze with crossing hairline pattern with semi-gloss sealing)



FBH - Fresh Bronze [HF]
(Anti-bronze with hairline pattern with semi-gloss sealing)



VDB - Dark Bronze Finish
(PVD bronze on polished surface with semi-gloss sealing)



REB - Red Bronze Finish
(Red bronze on hairline pattern with semi-gloss sealing)

Our Services



Ironmongery Schedule

We are preparing Schedules based on your Floor Plans and Design Intention for proposed or selected items to meet your requirements for each Door Mark. Our experienced Architectural Ironmongery Specialists work closely with you for any area of your project such as Typical Floor, Front of House, Back of House, Podium, Club House and others.

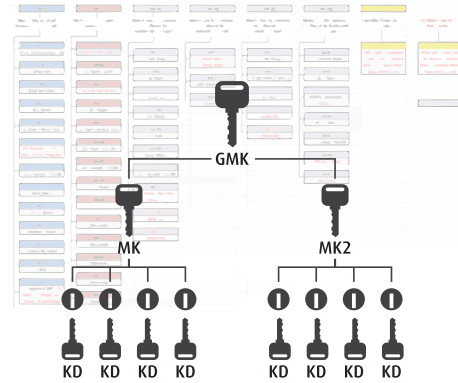

Master Keying System

We have an in-depth experience to provide Master Keysystems both for Residential and Commercial / Institutional Projects. Our Specialists are working on a sophisticated Software Platform to make our MKS proposals dynamic so that they can adapt to your growth and future needs in terms of Users, Doors and Access Rights. The Data and Masterkey Plans are stored confidentially as “Factory Systems” and can be retrieved for future use and Key Duplication. Our Masterkey Systems are based on Mechanical but also Mechatronic (Mix) or Electronic Credentials.

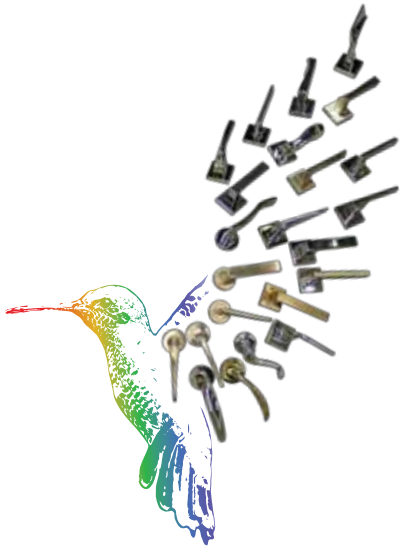

Product Customization

Our focus is not only on Proprietary Products but we can also conceptualize and prepare detailed Proposals for Customized Products & Solutions from our trusted Sources.



Sourcing

We are in constant contact with a large Pool of Suppliers, enabling us to source a wide range of Proprietary and Localized Products to meet your Needs and Requirements.



AUB Limited
Unit A, 12/F, Hung Mou Industrial Building,
62 Hung To Road, Kwun Tong,
Kowloon, Hong Kong
Tel : +852 2375 6110
Fax : +852 2406 2602
enquiry@aub.com.hk
www.aub.com.hk